

## Ice-Based Technique for Burst Testing of Tubular Elements

M. AKYURT, A.N.A. ALJAWI and S. ALDOUSARI

*Dept of Prod. Eng. & Mechanical Systems Design  
King Abdulaziz University, Jeddah 21589  
Correspondence: makyurt@kaau.edu.sa*

**ABSTRACT.** A survey of studies on freezing is presented, with special emphasis on the freezing of water pipes. An innovative technique is introduced for the generation of high pressures. Pressurization experiments are described where the two ends of water-filled pipe and tube specimens are frozen by the use of jackets of liquid carbon dioxide. The development of a special sensor is summarized for the measurement of pressures inside ice-bound bodies of liquid. Indicative pressures developed within the ice-bound regions of specimens made of commercial aluminum, copper and mild steel tubing are reported. Preliminary results seem to indicate that pressures in excess of 1000 bars can be developed by the use of the proposed new technique. It is concluded that the new ice-based technique possesses potential of application for the speedy leak and burst testing of tubular elements.

**KEYWORDS:** blockage, freezing, ice, pressure, sensor, testing, tubular specimen, water.

### 1. Introduction

Water is abundant on earth. It possesses unusual properties. And yet, considering how little use is being made of many of its properties, it may be stated that this precious resource has been hardly tapped. In what follows, efforts are outlined, to try to benefit from two of the many unusual properties of water - that of changes in its density during freezing and thawing, and its being essentially incompressible. The current effort proposes to dwell also on a third

significant property of water, which does not seem to have received much attention so far - the excellent sealing properties of ice.

Akyurt and associates [1] conducted a survey on freezing of water. They reported that most substances become denser as they are cooled, and they are denser in the frozen state than when liquid. When water is cooled below +4EC however, it begins to expand, such that when water freezes into ice, it becomes less dense than water. Thus the density of ice is  $0.917 \text{ Mg/m}^3$  at 0EC. They further pointed out that the thermal conductivity of ice is  $2.2 \text{ W/m/K}$ . When compared with the thermal conductivities of mild steel (45.5), aluminum (201) and glass wool (0.05), all in  $\text{W/m/K}$  [2], they suggested that perhaps it would be more correct to classify ice as an insulator than a conductor. Zaretsky and co-workers [3], working on other properties of ice, proposed an equation for estimating temporal creep strain development in ice, depending on stress, structural characteristics of ice and its temperature. DiMarco and associates [4] studied the flexural rigidity of sea ice, whereas Murat and Lainey [5] measured its Poisson's ratio.

The investigation of the process of freezing has been an intense area of research. Thus Sheshukov and Egorov [6] presented a numerical model for simulating the freezing of ground water in terms of an aqueous solution flow in saturated porous media. Alimov and co-workers [7] treated the hysteretic effect of freezing of groundwater as a Riemann problem with displacement, and solved the steady two-dimensional problem of freezing of groundwater.

The freezing phenomenon inside cavities and enclosures received a great deal of attention. Tsai [8] proposed a fully implicit Galerkin finite-element method with enthalpy formulation to solve the thermal control problem of the phase-change material in the square container of a spacecraft. Ismail and co-workers [9] carried out a parametric study on ice formation inside a spherical capsule. The governing equations of the problem and associated boundary conditions were formulated and solved using a finite difference approach and a moving grid scheme. The numerical predictions were validated by comparison with experimental results by the authors. The model was also used to investigate the effects of the size and material of the shell, initial temperature of the phase change material and the external temperature of the spherical capsule on the solidified mass fraction and the time for the complete solidification.

Braga and Viskanta [10] studied experimentally the effect of density variations on the solidification of water on a vertical wall of a rectangular cavity. Other investigators [11, 12] carried out investigations on freezing phenomena inside rectangular enclosures of various configurations. Devireddy

and associates [13] worked on the measurement and numerical analysis of freezing in solutions enclosed in a small container. Dolan and Gupta [14] made shock wave reverberation experiments on water samples, where water samples were quasi-isentropically compressed between silica and sapphire plates to peak pressures of 1–5 GPa on nanosecond time scales. Real time optical transmission measurements were used to examine changes in the compressed samples. They reported finding unambiguous evidence of bulk water freezing on such short time scales.

Lozowski, Jones and Hill [15] conducted a series of ice-sheet growth measurements in a small cold-room ice tank. They developed an approximate analytical theory for flooded ice growth. Aoki and co-workers [16] studied the freezing of water due to direct contact heat transfer, including sublimation. Saito [17], Yoon [18], Okawa [19] and their associates and still other researchers [20-23] studied factors affecting the freezing of supercooled water. Ohsaka and Trinh [24] worked on a device for measuring the velocity of growth of dendritic ice in undercooled water.

By far the most popular area of research in freezing has been the freezing process inside pipes. Due to its immediate practical importance, a large amount of research effort was concentrated on the process of freezing during various types of flows in water pipes [25-38]. Rinck and Beer [35] studied the solidification phenomenon inside an axially rotating pipe containing a turbulent liquid flow.

Of particular practical importance is the case when part of a pipe is completely blocked by ice, totally blocking any flow. In this connection Burton [39] and Burton and his associates [40] undertook experimental and numerical studies of plug formation in vertical pipes during pipe freezing. Tavner and co-workers [41] measured surface heat fluxes during the freezing of large diameter vertical pipes. They reported that heat flux data can be used as a means of monitoring ice-plug development, ensuring that a freeze seal is complete. Jeong and co-workers [42] undertook theoretical and experimental work on pipe freezing. They found that the effects of pipe diameter and freezing jacket length on ice plug formation are significant.

Richardson and associates [43] made studies for finding ways to accelerating freezing in non-circular pipes. A group of researchers headed by Hastaoglu [44] studied the heat transfer from a buried pipe. Keary and Bowen [45] studied the freezing phenomenon inside a vertical pipe. Hirata [46] and Hirata and Ishihara [47] investigated the freeze-off conditions in a water pipe that had a variation of flow passage with a cyclic pattern of contractions and expansions along the length of the pipe. In a related study, Petrenko and Peng

[48] reported a good correlation between the contact angle of water and the ice adhesion strength. Their study revealed that hydrogen bonding significantly enhances ice adhesion.

Some researchers viewed the blockage of ice inside pipes not as a problem but as a valuable phenomenon. Thus Richardson and co-workers [43] observed that local pipe freezing is increasingly used in a range of industries to solve otherwise intractable pipeline maintenance and servicing problems. There is, they noted however, a limit to the size of circular pipe that may be plugged using the technique. This is because ice and most other fluids encountered in their frozen state, are poor thermal conductors that tend to insulate the fluid remaining in the core of the pipe. They contended that for large diameters a closed plug cannot be formed no matter how much cooling is applied at the outer surface. To solve the problem, they conducted experiments to investigate the advantages of freezing non-circular sections. They were able to show that, by reducing the distance between the fluid and the cooled wall whilst at the same time maintaining the flow area of the pipe, there is no limit to the nominal size of line that may be plugged by freezing.

Essentially the same idea was utilized in the design of a “cold valve” [49] that was recommended for installation in pipelines. The said valve overcomes limitations to pipe freezing when applied to large diameter pipes by minimizing the distance between fluid and cooled wall, significantly improving the rate of heat transfer. This is achieved by narrowing the cross-section of the flow passage so that the fluid flows between cooled parallel plates. A secondary effect of narrowing the cross-section is that the tapered transition sections result in a self-locking plug which becomes tighter as pressure increases.

Bowen and associates [50] likewise acknowledged that pipe freezing (freeze sealing) is a technique which can be used on liquid filled pipelines to produce a solid, pressure resistant plug which can be used for the temporary isolation of a section of pipe. They discussed the safety implications of using this technique offshore, emphasizing the risk of plug failure, risk to the integrity of the pipe and the use of cryogenic liquids. Gagnon and co-workers [51] Used both on site NDT assessment and laboratory experiments to conduct a risk assessment of a potentially hazardous and costly maintenance operation involving the pipe freezing technique. The technique was required to create a temporary plug in a high-pressure bypass water pipe system in a hydroelectric generating station. The operation was required in order to permit the replacement of a faulty gate valve on a 4 inch (101 mm) cast iron water pipe, with an operating pressure of 1200 psi (82 bars). Prior to realizing the operation, a similar pipe circuit was built in a lab in order to duplicate the conditions at which the operation was to take place. During the laboratory test, stress measurements were made on the

frozen section of the pipe in order to evaluate the effect of the freeze on the pipe. Finally, the pipe freezing operation involving the thermal flux monitoring technique was successfully completed with only a few hours of downtime for the plant.

As yet another application of pipe freezing, Messelier-Gouze and co-workers [52] observed that, during maintenance operations in nuclear power plants, it is sometimes necessary to isolate temporarily sections of pipes. They concluded that, when no other mechanical device is available (floodgates, valves), the freeze sealing technique can be used. With a heat-exchanger surrounding a portion of the carbon-manganese pipe and filled with liquid nitrogen ( $-196^{\circ}\text{C}$ ), the water contained in the pipe is frozen, resulting in an ice-plug. During these operations, stresses of thermal origin are generated in the pipes, due to the thermal amplitude between the initial temperature of the pipes ( $40^{\circ}\text{C}$ ), and the coolant ( $-196^{\circ}\text{C}$ ). They recommended that the resistance of the pipe structure be studied, in particular to brittle fracture, in case of the presence of a small defect in the material of the pipe.

Another interesting use of the ice plug was discussed by Quarini [53], who conducted experimental and theoretical work to investigate the clean-in-place (CIP) and fouling removal capability of a novel patented crushed ice pigging system. The 'pig' consists of crushed ice in water with a freezing point depressant. The void fraction is carefully controlled so that the ice/water mix moves like a solid plug in free flow areas, but it is able to flow like a fluid in constricted areas. The ice pig is able to flow in pipes with sharp bends, through orifice plates, through T's and even in plate heat exchangers. The experimental work evaluating the 'cleaning efficiency' of this system indicated that the ice pig could easily and efficiently remove 'soft' fouling. The fouling materials tested included jam and fats (food industry), toothpaste (personal hygiene products) and fine slit and sand (river water cooled exchangers).

From an engineering design point of view, it is imperative to know about stresses developed during ice-plug operations. Lannoy and Flaix [54] conducted seven tests of freezing with liquid nitrogen on pipes representing circuits in thermal or nuclear power plants, using different geometrical configurations, steels and initial conditions. The stresses measured at the vicinity of the cooling jackets were below the elasticity limit. The tests also indicated that the resulting ice plug could withstand high pressures. Keary and co-workers [55-56] presented a review of experimental investigations on stress development, within the vicinity of the freeze jacket, during the blockage of a water-filled pipe by freezing. A wide spread of measured stress values was noted as well as a degree of uncertainty in the cases when the strain gauge output did not return to zero at the end of the freezing cycle. They also tried to predict the stress development

through a simple analytical model based on thin axisymmetric shell theory. They reported that there are important quantitative and qualitative differences between the measured and predicted values. Cui and Yang [57] and Lin and co-workers [58] presented simplified stress analysis models on freezing of pipes.

It is remarkable to observe at this point that none of the research efforts cited above dealt with pressures developed inside a confined body of water due to ice growth into it. The only exception to this trend is the recent work of Aldousari [59], who outlined several possible setups for ice-based pressurization. In what follows, we detail the process of freezing of a confined body of water inside a pipe when the pipe is cooled from the outside. Then a novel method of pressurization is introduced that is based on freezing. The emphasis in the treatment is the development and applications of the new method of pressurization, and not the exact values for the resulting pressures or stresses, or the repeatability and comparisons thereof. As for pressures, the bar ( $=14.5 \text{ lb/in}^2$ ) and  $\text{lb/in}^2$  are the dominant measures of pressure in the high-pressure domain, although MPa ( $1 \text{ lb/in}^2 = 6.895 \text{ kPa}$ ) is also occasionally used.

## **2. The Process of Freezing of a Confined Volume of Water**

Akyurt and associates [1] described several distinct stages during the freezing process inside a water pipe when it is exposed to constant sub-freezing ambient temperatures. They observed that heat must be transferred from the water, through the pipe wall and any insulation layers, to the sub-freezing air. Accordingly the temperature of the water begins to fall in a steep decline (Fig. 1). This is stage 1 of the freezing process. Remarkably, the water in the pipe does not immediately begin to freeze when it reaches the phase change temperature of  $0^\circ\text{C}$ , but continues to fall and approach the temperature of the surrounding air. This is a demonstration of supercooling. It is possible for water in a pipe to supercool for a considerable length of time before any ice forms. The pipe contains only water during stage 1. The last two digits in the time scale of Figs. 1 and 2 are minutes, and the rest are hours (local time).

The temperature at which ice begins to form is known as the ice nucleation temperature. Once the critical mass of nuclei is reached, the system nucleates and releases its latent heat faster than the heat that is being removed from the system. This is referred to as stage 2, where dendritic growth of needle-like ice flakes takes place. The temperature increases rapidly to  $0^\circ\text{EC}$  at the end of stage 2.

When the water in a pipe has completed dendritic ice formation and its temperature has returned to  $0^\circ\text{EC}$ , the third stage, the growth of annular ice

begins. Annular ice is the familiar dense form of ice, and it grows from the outside walls of the pipe inward. It is during annular ice growth that the remaining 94 to 98 percent of the water in the pipe turns into ice. During this phase, the pipe that is freezing will remain at phase change temperature until all of the water has turned into ice. Graphically, the stage 3 appears as a steady horizontal line at or near 0°C.

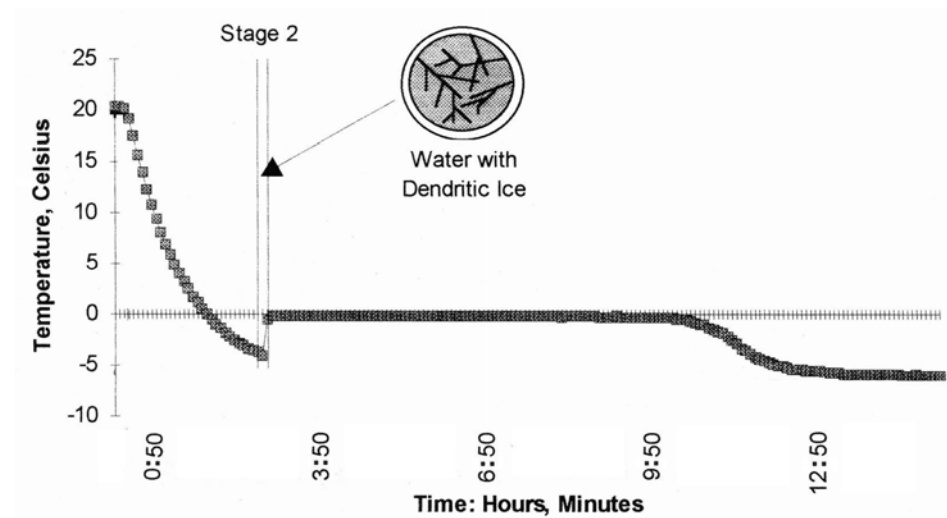

Fig. 1: Variation of temperatures with time inside a water pipe when the pipe is cooled uniformly from the outside [1].

When all of the water in the pipe has frozen (at about time 950, i.e., 9:50 A.M. in Fig. 1), the pipe starts to cool below phase change temperature, and eventually approaches the temperature of its environment. This is the fourth stage in the freezing process. When the temperature of the pipe has cooled to the same temperature as the surrounding air, the freezing process is complete. In stage four the pipe no longer contains water; it is blocked completely by a solid plug of ice.

Figure 2 shows the variation of temperatures in a section of a water pipe that was exposed to freezing conditions at night and melting conditions during the day. One end of the pipe was insulated, and it had a closed faucet on it. The same figure shows the variation of pressure inside the pipe at its faucet end. There is no noticeable pressure variation during the early phases of ice formation. The pressure inside the pipe stays exactly where it began, at the typical water pressure of the water system (around 42 psi = 0.3 MPa at the test site). Only when ice formation is complete at one end of the pipe does the

pressure within the pipe start to increase. In fact it grows dramatically, ultimately leading to a burst event. The pressure in the pipe peaks at about 4000 psi (270 bars = 27.6 MPa), and then it eases down to about 3500 psi (240 bars = 24 MPa) while the copper pipe undergoes plastic deformation under the influence of the imposed internal pressure. The actual rupture in the wall of the pipe occurs at about 7:15 A.M., when liquid water is ejected through the crack, bringing the pressure down to essentially zero.

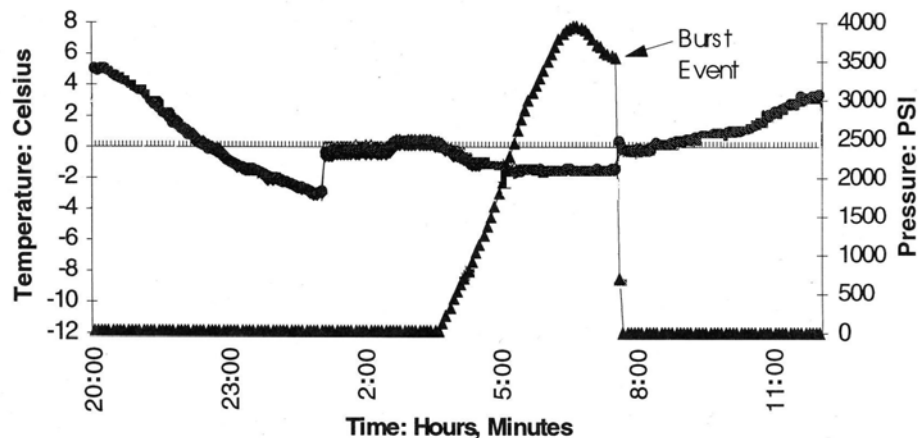

Fig. 2: Variation of temperatures and pressures with local time during pipe bursting [1].

It may be concluded that, when concentric rings of solid ice are allowed to grow into solid plugs of ice inside pipes, dangerously high pressures can be generated in confined volumes of water, resulting in the fracturing of the wall of the container, and the release of the pressure by forcing some of the remaining water through the cracks.

Splitting rocks without the use of dynamite is a well established procedure contractors resort to when working in freezing weather. They drill holes along the line of desired fissure, and then fill the holes with water. The expansion of the resulting ice causes the rocks to split without the clamor of dynamite.

A more recent mode of commercial application of freezing and thawing, aside from ice production and the freezing of foodstuffs, is in plumbing maintenance work, as reported by references [43, 50-52]. Engineers have been using ice plugs on piping to undertake maintenance chores without having to drain piping systems. Typically the pipe diameters may be small or large; industrial pipes of a diameter of up to 12" can be handled. One such system [60, 61] uses a bath of liquid nitrogen to establish and lock in place a solid plug of the fluid inside the pipe. It is stated [60, 62], without mentioning pipe sizes,



that such plugs can withstand pressures up to 8000 psig (540 bars=55 MPa) or 225,000 lbs (1000 kN) of axial force.

Kits are commercially available [62-67] for rapidly forming an ice plug in static small-diameter water lines,  $\frac{3}{8}$ " to  $2\frac{1}{8}$ " (9.5 mm to 54 mm) O.D.

### 3. Exploratory Experiments

One liter of water occupies a volume of  $1090.5 \text{ cm}^3$  when it turns into ice, indicating a 9% increase in volume. Since water, and also ice, are essentially incompressible, the argument goes that the increase in volume due to phase change can be used to do work.

$$W = \int p dV$$

where  $p$  is pressure and  $dV$  is the change in volume.

To identify the ingredients in this train of thought, a number of factors need to be considered:

- Factor (a): A confined space must be used to store water. This space must be capable of withstanding high internal pressures.
- Factor (b): A way must be found to turn water into ice in this confined space. The resulting expansion, when it is confined, will cause pressure to build up.
- Factor (c): The increase in pressure  $p$  of the system, and the volume increase  $dV$  may be used to do work  $W$ .

Figure 3 shows a schematic sketch for the use of freezing of water for internal isostatic pressurization. Here a vertical tube is indicated by number (1). The tube will become the casing of the pressure vessel that is to be achieved. A plain seal placed at the bottom of the tube is shown by (2). When the tube is filled by water (3), seal (2) is expected to prevent leaks caused by the head of water in the tube.

Near the two ends of tube (1) are placed donut - shaped freeze heads, which are cooling jackets (4). These freeze heads are to be cooled to temperatures that are considerably below the freezing temperature of water. The refrigeration system itself is not shown in Fig. 3. The aim is to freeze, in a reasonably short time, the volume of water (5) that is located in the immediate vicinity of the freeze heads (4).

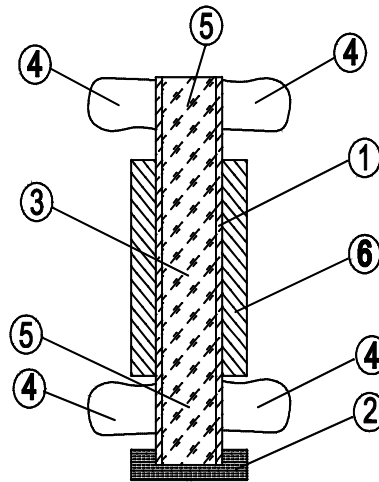

Fig. 3: Conceptual sketch for the use of freezing of water for internal isostatic pressurization.

Once both ends of tube (1) are completely sealed by ice plugs, tube (1) would be transformed into a high pressure vessel. This is partly because water that is trapped in the confined zone (3) is essentially incompressible. The other reason is, each unit of water that freezes in zone (3) occupies more volume when it turns into ice than the volume it occupied when it was water. The result is a steep rise in pressure in zone (3). Thus the more the ice plugs are allowed to grow, the higher the pressures will rise, until the tube deforms and then ruptures, releasing the pressure.

It may be further mentioned that a sleeve (6) can be provided outside tube (1) if interference-fit type of elastic or plastic deformations are desired [68].

It is assumed that tubular materials under consideration, like item 1 in Fig. 3, and shown separately in Fig. 4, are thin, i.e., the ratio of diameter  $D$  to thickness  $t$  is 20 or more. When subjected to an internal pressure  $p$ , the stress induced in the axial or longitudinal ( $x$ ) direction would be  $pD/(4t)$  whereas the hoop stress in the radial ( $y$ ) direction would be  $pD/(2t)$ . Since the hoop stress is twice the stress in the longitudinal direction, it follows that the tube would deform and then burst in the tangential direction and not in the longitudinal direction.

It follows from the above discussion that the tube, when subjected to internal pressures, would not deform significantly in the longitudinal ( $x$ )

direction. The preferential direction of deformations would be essentially tangential (y-direction).

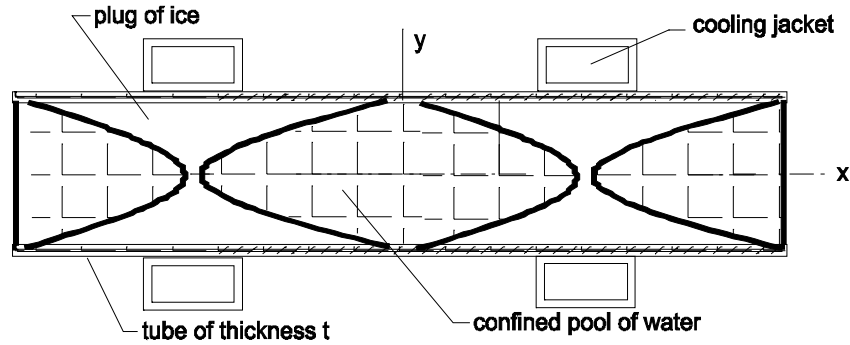

Fig. 4: Thin-walled water-filled tube blocked (sealed) by two plugs of ice.

A practical consequence of the above conclusion is that, during freezing experiments, the tube does not need to be anchored in the longitudinal direction. It follows further that attention must be paid to the measurement of radial (y-direction) displacements during experimentation, since the changes in radius would be due to circumferential stresses and strains. One would not expect significant displacements in the longitudinal (x) direction.

A commercial freezing kit [64] that is used in maintenance work for plumbing was employed. The kit is designed for use with liquid carbon dioxide,  $\text{CO}_2$ , which is a colorless and odorless gas which can be stored in liquefied form at room temperature under a pressure of about 58 bars (5.8 MPa). The density of the liquid at 25°C is 0.713 kg/liter [69]. The freezing heads are connected by flexible spiral tubing to an 80-kg industrial gas cylinder that is provided with a dip tube to enable the feeding of liquid carbon dioxide. Safety measures were observed by wearing safety glasses during tests, and by conducting all tests next to an open door for ventilation.

Following several preliminary experiments, it was decided to adopt the very simple test setup shown schematically in Fig. 5. The lower tray was used for storing tools and supplies, and the central wooden panel served as the vertical support for test specimens. Iron mongers' wire was used to quickly tie the specimen tubes to the panel via miniature holes previously drilled on the panel.

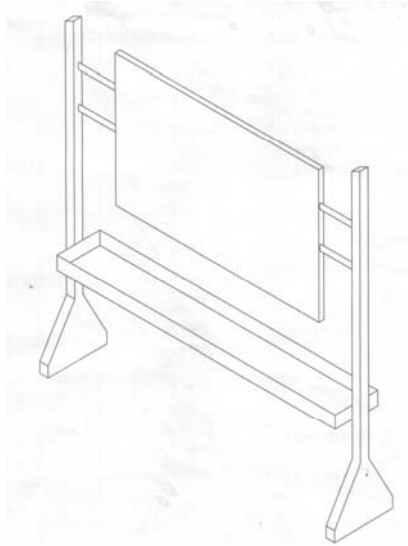

Fig. 5: The test stand design that was adopted.

In one of the exploratory experiments, an extruded aluminum pipe of outside diameter  $OD = 22$  mm was filled with tap water, insulated and tested, as shown in Fig. 5a, where only the central portion of the test specimen was left bare. The two freeze heads are visible with their ice coatings. At about 7 minutes after the start of the test a chirp was heard, and it was noticed that the aluminum pipe had burst at the location of the expected bulge area (Fig. 6). No visible bulging was observed at this location before the bursting. Water was ejected out of the split in the pipe. The shape of the water jet is visible in Fig. 6 as it wetted the wooden panel of the test stand.

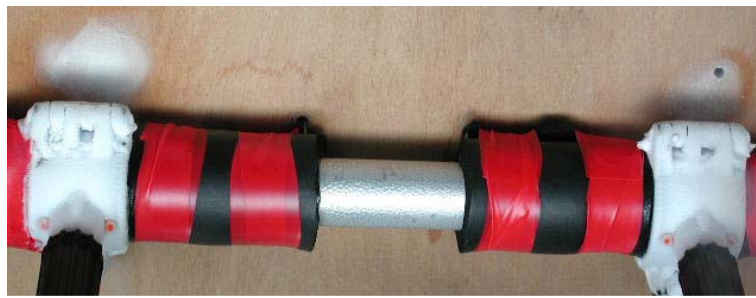

Fig. 5a: The freeze-testing of an extruded aluminum pipe (vertical) after extensive insulation.

Next a 1" (25.4 mm) OD hard temper copper tube was insulated and tested, in the same manner as the aluminum tube. When the burst occurred (Fig. 7) about half an hour after the start of the test, the bang was much louder than that for the aluminum tube, and the accompanying jet of water was more forceful.



Fig. 6: The split in the extruded aluminum pipe, and the shape of the ejected water jet on the support panel.



Fig. 7: The split formed at the central zone of the copper tube.

#### **4. Measurement of Pressures Developed during Freezing**

While it may be considered exciting to be able to burst open pipes with the use of the new tool of pressurization by freezing, it would also be of interest to

identify the pressures developed during the process. To this end a compact “T” arrangement was designed as a setup for monitoring pressures, with a pressure gauge mounted on the stem of the T (Fig. 8). Galvanized 3/4" (19.1 mm) mild steel (MS) water pipes were tightly threaded to the brass head of the T and then filled with tap water, freezing heads were attached, and the entire system was insulated. Pressures started rising soon after the beginning of the test, and kept rising even after the carbon dioxide flow was shut off when a pressure of 1000 bars (101 MPa) was reached (Fig. 8). The test was terminated in order not to damage the gauge.

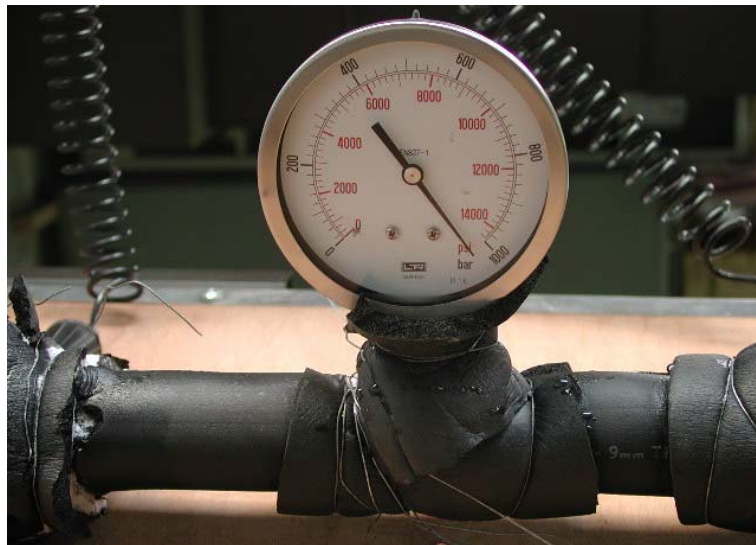

Fig. 8: Testing of pressures with a dial gauge of range 1000 bars (101 MPa).

The measuring of pressures with a dial gauge is informative but it is not very practical. This is because, using a dial gauge, every new pipe or tubular element to be tested must be provided with a T-setup of its own. This would be tedious, time consuming and many times impractical. What is needed is a way to readily measure pressures inside common metallic tubular elements of various sizes and also of various non-metallic materials, including composite materials.

A pressure sensor (Omega, PX602) with a range of 20 000 psi (1360 bars = 138 MPa) was available. This sensor, like all other sensors of this and higher ranges obtainable via the Internet, was not made to withstand pressures larger than 0.05 MPa. This property precluded the insertion of the sensor into the

pressure chamber. A means had to be devised therefore to bring the sensor into contact with the pressurized pool of water inside the pipe or tube being tested.

For this purpose a steel adaptor was manufactured for screw connection to the sensor, and a 1/2" (12.7 mm) seamless steel tube of 60 cm length was welded to the adaptor. The adaptor assembly was tightly screwed to the sensor. Then the sensor tube was filled with a suitable anti-freeze (glycol solution) to make certain that the solution inside the sensor tube does not freeze when the outside of the sensor tube is encased in ice. The end of the sensor tube was capped by a cork plug, to act like a semi-permeable membrane, not letting the anti-freeze liquid inside the sensor pipe to drain into the pressure chamber, and yet allow the pressurized water surrounding the sensor pipe to be felt by the sensor. A specially designed retaining sleeve (Fig. 9) was screwed to the cork-plugged end of the sensor pipe to keep the plug in place during cases of sudden de-pressurization of the system.

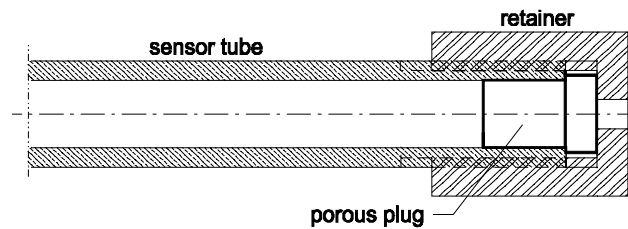

Fig. 9: Retaining sleeve and cork plug at the end of the sensor tube.



Fig. 10: Fully insulated test system with a seamless sensor pipe (above) and a dial gauge.

Figure 10 shows a test assembly comprising the 3/4" (19.1 mm) pressure chamber with the "T" to accommodate the dial gauge. The end of the toy rubber balloon that was used to seal the bottom end of the pressure chamber is visible at the bottom of the picture. The two freeze heads as well as the rest of the system are insulated with 10 mm thick foam insulation. A cloud of carbon

dioxide vapor emerging from the upper freeze head is noticeable. Part of the sensor pipe is visible as it protrudes from the upper end of the pressure chamber.

The 3/4" (19.1 mm) galvanized steel pipes comprising the pressure chamber were brought into a vertical position, as shown in Fig. 10, and the freeze heads were connected to the CO<sub>2</sub> cylinder. The sensor pipe was inserted into the pressure chamber such that the tip of the sensor pipe reached the "T" junction of the pressure chamber. The pressure chamber was then filled with tap water, and an experiment was started by opening the CO<sub>2</sub> valve. Figure 11 displays the timewise variation of pressures as indicated by the pressure sensor as well as the gauge.

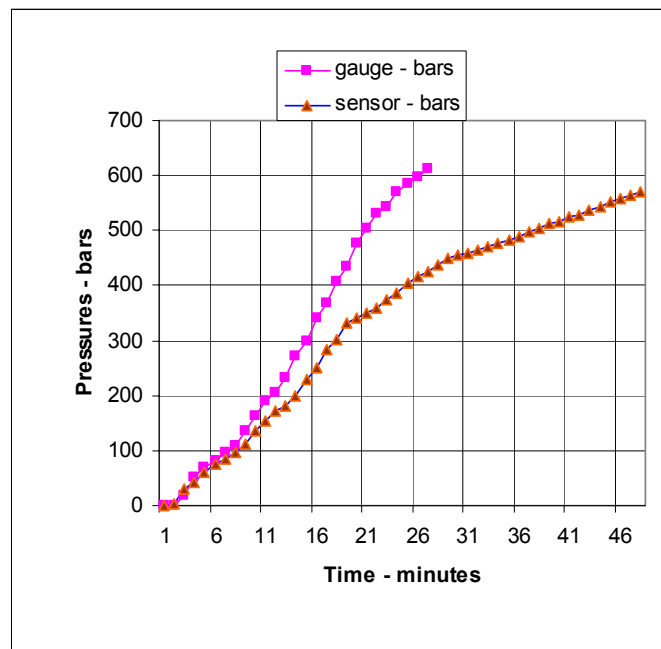

Fig. 11: Timewise variation of pressures as indicated by the dial gauge and the pressure sensor.

The test of Fig. 11 was repeated a number of times. Several of the system components failed during these trials, like the "T" junction, the 3/4" (19.1 mm) galvanized chamber pipe, and the brass adaptor on the dial gauge. Each time, the relevant part or parts were replaced by stronger replacements. A number of leaks were also spotted at several junctions, and these were promptly sealed properly. Pressures of 800 bars (81 MPa) were routinely reached, and the 1000-bar (101 MPa) mark was exceeded a number of times.



The results of calibration tests were examined, and the following relationship was established between the reading of the dial gauge (bars) and the output from the pressure sensor (mV):

$$\text{Gauge pressure}/100 = 0.219 + 11.934*S + 32.317*S^2 - 9.377*S^3$$

where S= sensor reading (mV) /100.

### 5. Leakage and Bursting Tests

Once the new special freezing sensor was developed, more tests were undertaken to quantify the pressures caused by freezing. Figure 12 shows the test setup schematically, without insulation. Thus a brass-colored seam-welded aluminum pipe of OD=28.25 mm was fully insulated, and freeze tested, with the sensor in place. Figure 12a shows the variation of pressures inside the tube with time. The pressure peaked to a maximum of about 33 bars (3.3 MPa), and then eased down gradually, indicating a substantial amount of bulging. Figures 13a and 13b show the resulting opening in the seam and the bulging in the same vicinity.

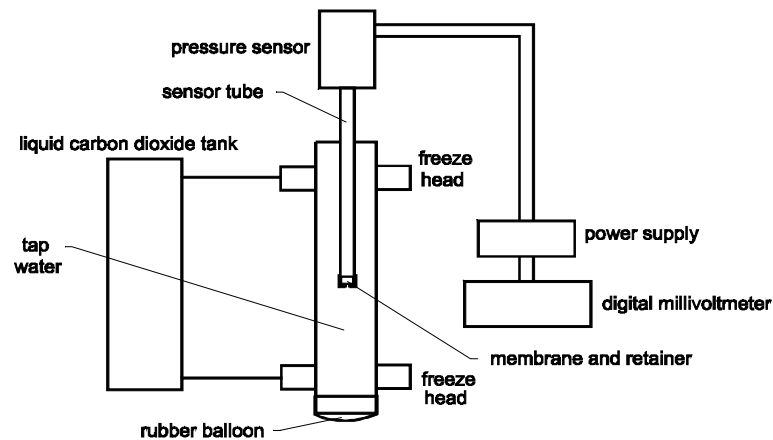

Fig. 12: Schematic arrangement for the burst and leak testing of a tubular specimen.

A test was conducted next on a 1¼" (31.8 mm) hard temper copper pipe for plumbing service, of wall thickness  $t = 1.65$  mm. A length of 60 cm of the pipe was fully insulated. Figures 14a and 14b show the test results. It is thus clear that the pipe is able to sustain pressures in excess of 500 bars (50.7 MPa), after which it ruptures suddenly, without any appreciable bulging.

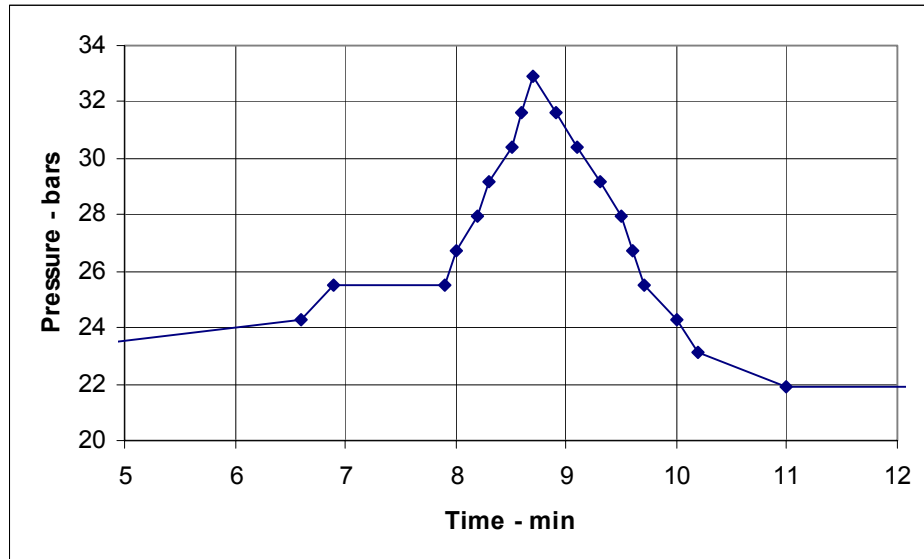

Fig. 12a: Burst testing of seam welded aluminum pipe (OD=28.25 mm).



Fig. 13a: The splitting of the seam in the aluminum pipe.



Fig. 13b: The bulging in the seam welded aluminum pipe.

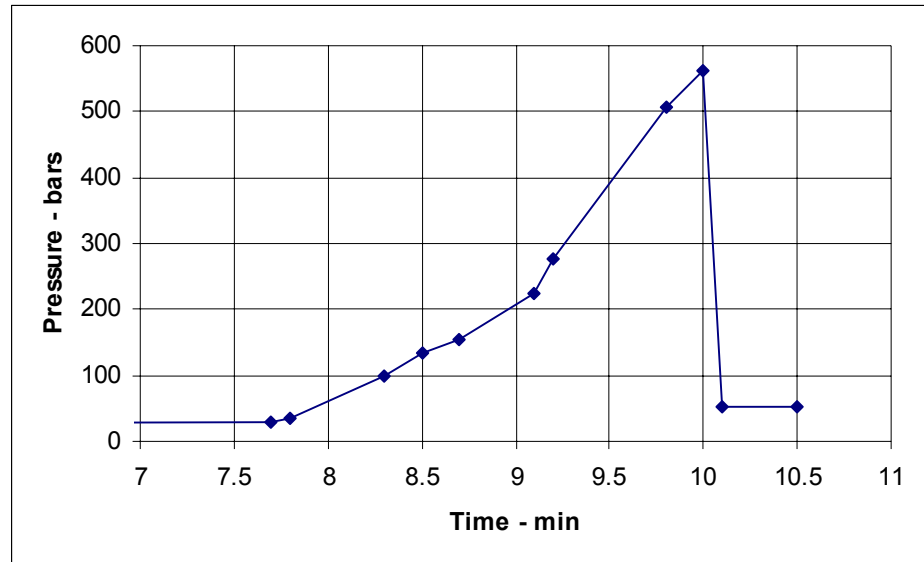

Fig. 14a: Burst-testing of 1.25" (31.8 mm) hard temper copper tube.



Fig. 14b: The rupture on the hard temper 1.25" (31.8 mm) copper pipe.

An extruded aluminum pipe was tested next. To this end, a 1½" diameter (38.1 mm OD,  $t = 2.11$ ) hard temper aluminum tube, 60 cm in length, was fully insulated, and fitted with the same sensor pipe. Figure 15 depicts the development of pressure inside the pipe, and Figs. 15a and 15b show the displacements. It follows from Fig. 15 that the pipe is able to endure pressures in excess of 250 bars (25 MPa). Once a pressure of about 300 bars (30.4 MPa) is reached, bulging starts to take place (Fig. 15a). This is evidenced by the easing down of the pressure in the pipe to about 275 bars (27.9 MPa). A sudden rupture (Fig. 15b) follows the bulging, bringing down the pressure in the pipe to essentially zero.

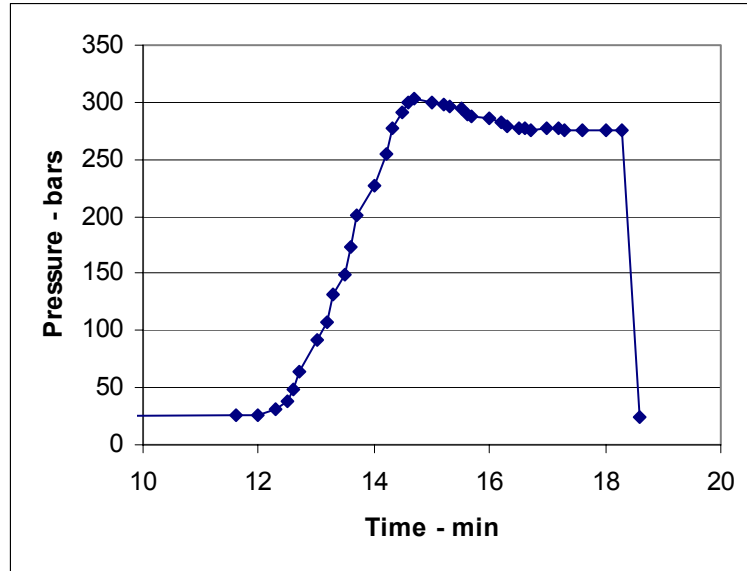

Fig. 15: Burst-testing of 1.5" (OD=38.1 mm,  $t=2.1$ mm) aluminum tube.



Fig. 15a: Bulging in the aluminum pipe after reaching a pressure of 300 bars (30.4 MPa).



Fig. 15b: The rupture in the aluminum pipe after its bulging.

A thin steel pipe 1" in diameter (OD=33.4 mm and  $t = 1$  mm), seam welded along its length, was cut to a length of 60 cm. A test was started after fully insulating the system. Figure 16 shows the variation of pressures with time. It follows that the pipe failed along the seam at the center of the specimen when the pressure reached barely 300 bars (30.4 MPa), and there was no indication of any bulging. In fact the line of failure was hardly discernable by naked eye. Since failure at such a low pressure was not expected, this test was repeated on the same pipe specimen. The behavior was found to be the same, except that the pipe leaked at about 260 bars (26.3 MPa), instead of at 300 bars (30.4 MPa). These tests demonstrated therefore that the thin-walled seam welded steel pipe is only as strong against bursting as an extruded aluminum tube of similar diameter and thickness.

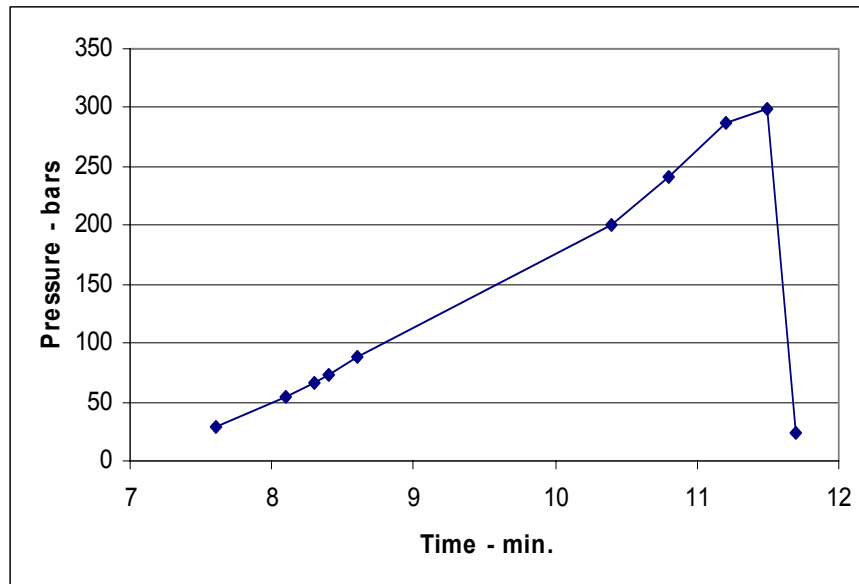

Fig. 16: Burst-testing of seam-welded thin steel pipe (OD=33.4mm,  $t=1$  mm)

Figure 17 shows the pressures developed inside a schedule 40 MS pipe of diameter  $\frac{3}{4}$ " (OD=26.67 mm,  $t=2.87$  mm), also seam welded, during a subsequent test. Pressures are observed to rise monotonically until about 1000 bars (101 MPa). Then there is a peaking and easing of pressures, typical of a yield, after which a further rise commences, albeit at a much slower pace and slope.

The peak in Fig. 17 is to be attributed to a rupture in the seam at the central un-frozen region of the pipe. Due to the relatively elevated strength of the pipe, the rupture in a steel pipe does not take the form of a tear, as in the cases of aluminum and copper pipes, but the area of failure is still visible, as indicated in Fig. 17a.

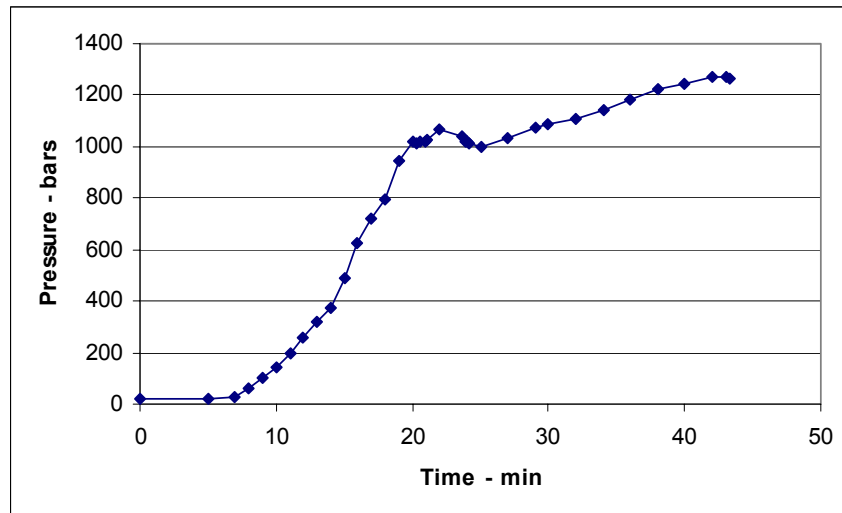

Fig. 17: Burst-testing of seam-welded  $\frac{3}{4}$ " schedule 40 MS pipe ((OD=26.67 mm, t=2.87 mm)).



Fig. 17a: The line of fracture on the seam of the MS pipe of OD=26.67 mm, t=2.87 mm.

The upper freeze head burst with a big bang during the conduction of this experiment. Both freeze heads were insulated by several layers of black foam insulation that is used for insulating refrigeration pipes. The pipe itself had one layer of the same insulation in pipe form.

## 6. Discussion and Conclusions

Existing studies on freezing and ice blockage in pipes and tubular elements focus on the development of thermal stresses under the freeze jacket, where a block of ice has been formed. The stresses developed on the outer surfaces of the pipes in these regions are hence invariably compressive due to large temperature differences between the pipe skin and the ice inside the pipe.

The current study, in contrast, concentrates on the generation of high pressures within the body of un-frozen water inside pipes and tubes, midway between the freeze heads, and hence away from the region of the freeze jackets. Consequently each and every one of the tested tubes and pipes are under tension due to generated internal pressures. There does not seem to be any scientific work published on the generation of these stresses. According to available commercial literature [60, 63-66], the maximum pressure that an ice blockage can sustain inside a tube (of un-specified diameter) is not more than 550 bars (56 Mpa). Numerous tests conducted during the current study however, have demonstrated beyond any doubt, that ice blockage can sustain much higher pressures. Pressures in the vicinity of 1300 bars (132 MPa) have been recorded on a number of occasions during the current study.

It must be emphasized that the stresses reported here are for order-of-magnitude purposes only. The main aim is to demonstrate the possibilities that the new method offers in general. No attempt has been made to check the repeatability of the tests nor to compare results with theoretical predictions or the results of other test techniques.

It may be deduced from the experience gained by the authors during extensive testing that, for maximum speed of freezing and of pressure development, the following points should be heeded:

- a) The system must be well insulated against heat gains from the environment. This is by far the most important point to heed in high pressure testing by freezing.
- b) It must be ensured that sufficient heat transfer surface is available at the freezing heads for the specific cooling job. It is understood that an adequate flow rate of liquid carbon dioxide is available.
- c) While insulating freezing heads, allowance must be made for the subliming carbon dioxide gas to escape. Failure to observe this precaution can result in the accumulation of pressure, up to about 58 bars (5.9 Mpa), in the neighborhood of freezing heads, and it can cause explosions.
- d) In case there is a choice of diameters of tubes to be tested, small-diameter tubes are to be preferred for shorter test durations.

- e) Tubes made of materials with high thermal conductivity yield results faster. The use of inserts and wraps with high thermal conductivity can be considered for low-thermal conductivity materials.
- f) The material of the tube to be tested must not have its glass transition temperature within the operational range of the process.

It is concluded that the method of ice-based pressurization, which is introduced here, is a totally new concept for leak and burst testing of tubular elements. It seems to have the potential to become a powerful and practical new technique for the burst and leak testing of a wide range of tubular materials at 0°C. Plans are underway to try to extend the testing zone to about 30°C.

One major advantage is that ice-based pressurization does not require heavy investments and bulky equipment. A second important feature is the ease of sealing of specimens. It is suggested hence that the new technique seems to possess the ingredients for enabling the conduction of burst and leak testing even in the field. Tests can be undertaken relatively rapidly by using mobile kits.

### References

- [1] **Akyurt, M., G. Zaki and B. Habeebullah**, Freezing phenomena in ice-water systems, *J. Energy Conv. Management*, 43 pp 1773 - 1789, 2002.
- [2] **Kreith, F.** (1968), Principles of heat transfer, 2<sup>nd</sup> Ed., International Textbook Co., Scranton, Penn, pp 471 - 477.
- [3] **Zaretsky, Yu. K., B. D. Chumichev and V. I. Solomatin**, Ice behaviour under load , *International Communications in Heat and Mass Transfer*, Volume 23, Issue 5 , September-October 1996, Pages 679-685.
- [4] **DiMarco, R. L., J. P. Dugan, W. W. Martin and W. B. Tucker**, Sea ice flexural rigidity: a comparison of methods, *Cold Regions Science and Technology*, Volume 21, Issue 3 , May 1993, Pages 247-255.
- [5] **Murat, J. R. and L. M. Lainey** , Some experimental observations on the Poisson's ratio of sea-ice, *Cold Regions Science and Technology* Volume 6, Issue 2 , November 1982, Pages 105-113.
- [6] **Sheshukov, A.Y., Egorov, A.G.**, Frozen barrier evolution in saturated porous media, *Advances in Water Resources*, Jun2002, Vol. 25 Issue 6, p591, 9p.
- [7] **Alimov, M., K. Kornev and G. Mukhamadullina**, Hysteretic Effects In The Problems Of Artificial Freezing, *Siam J. Appl. Math.*, 1998, *Society for Industrial and Applied Mathematics*, Vol. 59, No. 2, pp. 387/410.
- [8] **Tsai, J.R.**, Phase-change thermal control in a square container, *Trans Aeron Astron Soc Rep China*, v 32 n 4, p 327-333, 2000.
- [9] **Ismail, K.A.R., J.R. Henr.quez, T.M. da Silva**, A parametric study on ice formation inside a spherical capsule, *International Journal of Thermal Sciences* 42 (2003) 881-887.
- [10] **Braga, S. L. and R. Viskanta**, Effect of density extremum on the solidification of water on a vertical wall of a rectangular cavity, *Experimental Thermal and Fluid Science* Volume 5, Issue 6, November 1992, Pages 703-713.



- [11] **Leong, K. C. and F. L. Tan**, Experimental study of freezing in a rectangular enclosure, *Journal of Materials Processing Technology*, Volume 70, Issues 1-3 , October 1997, Pages 129-136.
- [12] **Cao, W. Z. and D. Poulidakos**, Experiments on the transient freezing of water in an inclined rectangular cavity, *International Journal of Heat and Fluid Flow*, Volume 12, Issue 2 , June 1991, Pages 116-121.
- [13] **Devireddy, R. V., P. H. Leo, J.S. Lowengrub, J.C. Bischof**, Measurement and numerical analysis of freezing in solutions enclosed in a small container, *International Journal of Heat and Mass Transfer* 45 (2002) 1915–1931.
- [14] **Dolan, D.H. and Y.M. Gupta**, Time-dependent freezing of water under dynamic compression, *Chemical Physics Letters*, 374 (2003) 608–612.
- [15] **Lozowski, E. P., S. J. Jones and B. Hill**, Laboratory measurements of growth in thin ice and flooded ice, *Cold Regions Science and Technology*, Volume 20, Issue 1 , November 1991, Pages 25-37.
- [16] **Aoki, Kazuo, Masayuki Sawada, Masatoshi Akahori**, Freezing due to direct contact heat transfer including sublimation, *International Journal of Refrigeration*, 25 (2002) 235–242.
- [17] **Saito, A., S. Okawa, A. Tojiki, H. Une and K. Tanogashira**, Fundamental research on external factors affecting the freezing of supercooled water. *Int. J. Heat Mass Transfer* 35 10 (1992), pp. 2527–2536.
- [18] **Yoon, Jung In, Choon Geun Moon, Eunpil Kim, Young Seok Son, Jae Dol Kim, Toyofumi Kato**, Experimental study on freezing of water with supercooled region in a horizontal cylinder, *Applied Thermal Engineering*, 21 (2001) 657-668.
- [19] **Okawa, Seiji, Akio Saito, Hidekazu Suto**, The experimental study on freezing of supercooled water using metallic surface, *International Journal of Refrigeration* 25 (2002) 514–520.
- [20] **Kumano, H., Saito, Akio; Okawa, Seiji; Suzuki, Yukiyoishi**, Simulation on solidification process of flowing supercooled water, *Nippon Kikai Gakkai Ronbunshu, B Hen/Transactions of the Japan Society of Mechanical Engineers, Part B*, v 69, n 678, February, 2003, p 461-469.
- [21] **Sarbu, I., Kalmar, F.**, Numerical simulation and prevention of water freezing in outdoor penstocks, *Journal of Hydraulic Research/De Recherches Hydrauliques*, v 39, n 4, 2001, p 437-443.
- [22] **Tsutomu Hozumi, Akio Saito, Seiji Okawa, Takayoshi Matsumura**, Effect of bubble nuclei on freezing of supercooled water, *International Journal of Refrigeration* 25 (2002) 243–249.
- [23] **Seiji Okawa , Akio Saito, Ryuta Minami**, The solidification phenomenon of the supercooled water containing solid particles, *International Journal of Refrigeration* 24 (2001) 108-117.
- [24] **Ohsaka, K., E.H. Trinh**, Apparatus for measuring the growth velocity of dendritic ice in undercooled water, *Journal of Crystal Growth* 194 (1998) 138–142.
- [25] **Tsai, C. W., S. J. Yang and G. J. Hwang**, Maximum density effect on laminar water pipe flow solidification, *International Journal of Heat and Mass Transfer*, Volume 41, Issue 24 , 1 October 1998, Pages 4251-4257.
- [26] **Zerkle, R.D., J.E. Sunderland**, The effect of liquid solidification in a tube upon laminar flow heat transfer and pressure drop, *Journal of Heat Transfer* 90 (1968) 183–190.
- [27] **Depew, C.A., R.C. Zenter**, Laminar flow heat transfer and pressure drop with the freezing at the wall, *International Journal of Heat and Mass Transfer* 12 (1969) 1710–1714.
- [28] **Hwang, G.J., J.P. Sheu**, Liquid solidification in combined hydrodynamic and thermal entrance region of a circular tube, *The Canadian Journal of Chemical Engineering* 54 (1976) 66–71.

- [29] **Mulligan, J.C., D.D. Jones**, Experiments on heat transfer and pressure drop in a horizontal tube with internal solidification, *International Journal of Heat and Mass Transfer* 19 (1976) 213–219.
- [30] **Özsisik, M.N., J.C. Mulligan**, Transient freezing of liquids in forced flow inside circular tube, *Journal of Heat Transfer* 91 (1969) 385–390.
- [31] **Hwang, G.J., C.W. Tsai**, Effect of natural convection on laminar pipe flow solidification, *International Journal of Heat and Mass Transfer* 38 (1995) 2733–2742.
- [32] **Hwang, G.J., C.W. Tsai**, Theoretical and experimental studies of laminar mixed convection in water pipe flow with density inversion effect, *International Journal of Heat and Mass Transfer* 40 (1997) 2019–2033.
- [33] **Tavner, A.C.R.**, An experimental study of ice formation and convection during cryogenic pipe freezing. *Ph.D. thesis*, University of Southampton, U.K (1992).
- [34] **Law, K.M.**, An investigation into cryogenic pipe freezing. *Ph.D. thesis*, Paisley College of Technology, Glasgow, U.K (1989).
- [35] **Rinck, K.J. and H. Beer**, Solidification inside an axially rotating pipe containing a turbulent liquid flow, *International Journal of Heat and Mass Transfer* 42 (1999) 4375–4389.
- [36] **Haneef, M. and A. Aziz**, Experimental study of inward freezing in circular and square pipes, *International Journal of Pressure Vessels and Piping* Volume 76, Issue 4, April 1999, Pages 221–243.
- [37] **Zubkov, P.T.; Kravchenko, V.A.; Sviridov, E.M.**, Simulation of the process of water freezing in a round pipe, *Teplofizika Vysokikh Temperatur*, v 39, n 5, 2001, p 777–784.
- [38] **Cervantes, J.; Trevino, C.; Mendez, F.**, Asymptotic analysis for the transient freezing and laminar flow in a circular pipe, *Heat Transfer, Proceedings of the International Heat Transfer Conference*, 1990, p 321.
- [39] **Burton, M.J.**, An experimental and numerical study of plug formation in vertical pipes during pipe freezing. *Ph.D. thesis*, University of Southampton, U.K (1986).
- [40] **Bowen, R.J. M.J. Burton and G.S. Smith**, The effect of pipe diameter and pressure drop on the formation of ice plugs in pipelines. *Ninth International Heat Transfer Conference* (1990).
- [41] **Tavner, A.C.R., Bowen, R.J.; Bishop, C.W.**, Heat flux monitoring during cryogenic pipe freezing: A case study, *Chemical Engineering Research & Design, Transactions of the Institution of Chemical Engineers, Part A*, v 74, n A2, Mar, 1996, p 239–241.
- [42] **Jeong, Gi Ho, Seong, Young Sik; Ahn, Byung Jin; Kim, Kui Soon**, Numerical analysis of phase change and natural convection phenomena during pipe freezing process, *American Society of Mechanical Engineers, Pressure Vessels and Piping Division PVP*, v 448, n 2, 2002, p 145–149.
- [43] **Richardson, R. N. , R. J. Bowen, A. Sharman**, Accelerated Pipe Freezing in Non-circular Sections, *Chemical Engineering Research & Design: Transactions of the Institution of Chemical Engineers Part A*; Apr 2003, Vol. 81 Issue 4, p467, 7p.
- [44] **Hastaoglu, Mehmet Alaittin, Antoine Negiz<sup>†</sup> and Robert A. Heidemann**, Three-dimensional transient heat transfer from a buried pipe—Part III. Comprehensive model, *Chemical Engineering Science*, Volume 50, Issue 16, August 1995, Pages 2545–2555.
- [45] **Keary, A.C and R. J. Bowen**, Analytical study of the effect of natural convection on cryogenic pipe freezing, *International Journal of Heat and Mass Transfer*, Volume 41, Issue 10, May 1998, Pages 1129–1138.
- [46] **Hirata, T.**, Effects of friction losses in water-flow pipe systems on the freeze-off conditions, *International Journal of Heat and Mass Transfer* Volume 29, Issue 6, June 1986, Pages 949–951.
- [47] **Hirata, T., M. Ishihara**, Freeze-off conditions of a pipe containing a flow of water, *International Journal of Heat and Mass Transfer*, Volume 28, Issue 2, February 1985, Pages 331–337.

- [48] **Petrenko, V.F. and S. Peng**, Reduction of ice adhesion to metal by using self-assembling monolayers (SAMs), *Can. J. Phys.* 81: 387–393 (2003).
- [49] **Low Temperature Engineering**, Cold valve freezes maintenance costs, *Professional Engineering*, 2002, p 68.
- [50] **Bowen, R.J., Keary, A.C.; Syngellakis, S.**, Pipe freezing operations offshore - some safety considerations, *Proceedings of the International Conference on Offshore Mechanics and Arctic Engineering - OMAE*, v 5, *Pipeline Technology*, 1996, p 511-514.
- [51] **Gagnon, D.; Adam, R.; Beauchemin, R.; Godin, S.; Nguyen, P.V.; Nguyen-Duy, P.; Bishop, C.W.**, Operational risk assessment of a valve replacement operation using a pipefreezing technique and heat flux monitoring to determine positive isolation on a high pressure live water line at 1300 psi (89 bar), *Proc. Int. jt. Power Gener. Conf.*, v 2 2001, p 491-497.
- [52] **Messelier-Gouze, Clarisse; Brezillon, Christian; Tubiana, Andre; Rousseau, Gilles**, Justification of the use of liquid nitrogen to make ice-plugs in carbon-manganese steel pipes for maintenance purposes in nuclear power plants, *ASME Pressure Vessels Piping Div Publ PVP*, v 443, n 2, 2002, p 45-50.
- [53] **Quarini, J.**, Pigging to reduce and remove fouling and to achieve clean-in-place, *Applied Thermal Engineering* 22 (2002) 747–753.
- [54] **Lannoy, A. and B. Flaix**, Experimental analysis of the obturation of pipes by ice plugs, *Nuclear Engineering and Design* Volume 86, Issue 3, June 1985, Pages 305-313.
- [55] **Keary, A C, S Syngellakis and R J Bowen**, Experimental and analytical study of thermal stresses during pipe freezing, *Proc Instn Mech Engrs* Vol 215 Part E, pg 63 – 77, 2001.
- [56] **Syngellakis, S.; Keary, A.; Bowen, R.J.**, On the prediction of stresses in pipes caused by ice plug formation, *Proc Inst Mech Eng Part E J Process Mech Eng*, v 210 n E3 1996 p 151-158.
- [57] **Cui, Guangxin; Yang, Weihao**, Stress analysis on freezing pipes by modelling test, Ground Freezing, 1991, p 219, *Proceedings of the 6th International Symposium on Ground Freezing*, Sep 10-12 1991, Beijing, China.
- [58] **Lin, S.; Gao, D.Y.; Yu, X.C.**, Thermal stresses induced by water solidification in a cylindrical tube, *J Heat Transfer Trans ASME* v 112 n 4 Nov 1990 p 1079-1082.
- [59] **Aldousari, S.**, Utilization of Phase Change for Sealing and Pressurization of Tubular Elements, *J KAAU: Engineering Sciences*, v 15 n 2, 2004 p 89-107.
- [60] <http://www.bishop.co.uk/>, About pipe freezing (2004),
- [61] **Schneider, R.**, Liquid nitrogen simplifies pump removal from shuttle, *Hydraulics & Pneumatics*, 6, Sept 2000.
- [62] [www.pipefreezing.com](http://www.pipefreezing.com). Freeze Service (2003)
- [63] [www.cob-industries.com](http://www.cob-industries.com), COB Industries (2003).
- [64] <http://www.pollardwater.com/> Cold-Shot Pipe Freeze Kit (2003).
- [65] <http://www.cryostop.com/>, Cryostop International, 2003.
- [66] <http://www.rothenberger-usa.com/19.html> Rofrost, 2003;
- [67] **Statesupply** (2003), Pipe Freeze Kits, [info@statesupply.com](mailto:info@statesupply.com).
- [68] **Habeebullah, B., G. Zaki and M. Akyurt**, A prototype device for converting freezing energy into mechanical work, *J. Energy Conv. Management*, v 44 pp 251-265, 2003.
- [69] <http://www.koac.com/pdf/carbondioxide.pdf> Koac, (2004).

E-mail: [makyurt@kau.edu.sa](mailto:makyurt@kau.edu.sa)

.( 1000 )